

DOOR SPACE GUARD REQUIRED TO COMPLY WITH ASME A17.1-2019 SECTIONS 5.3.1.8.2 AND 5.3.1.9.3 (b). CONTACT LOCAL CODE AUTHORITY FOR SPACE GUARD SIZE REQUIREMENTS.

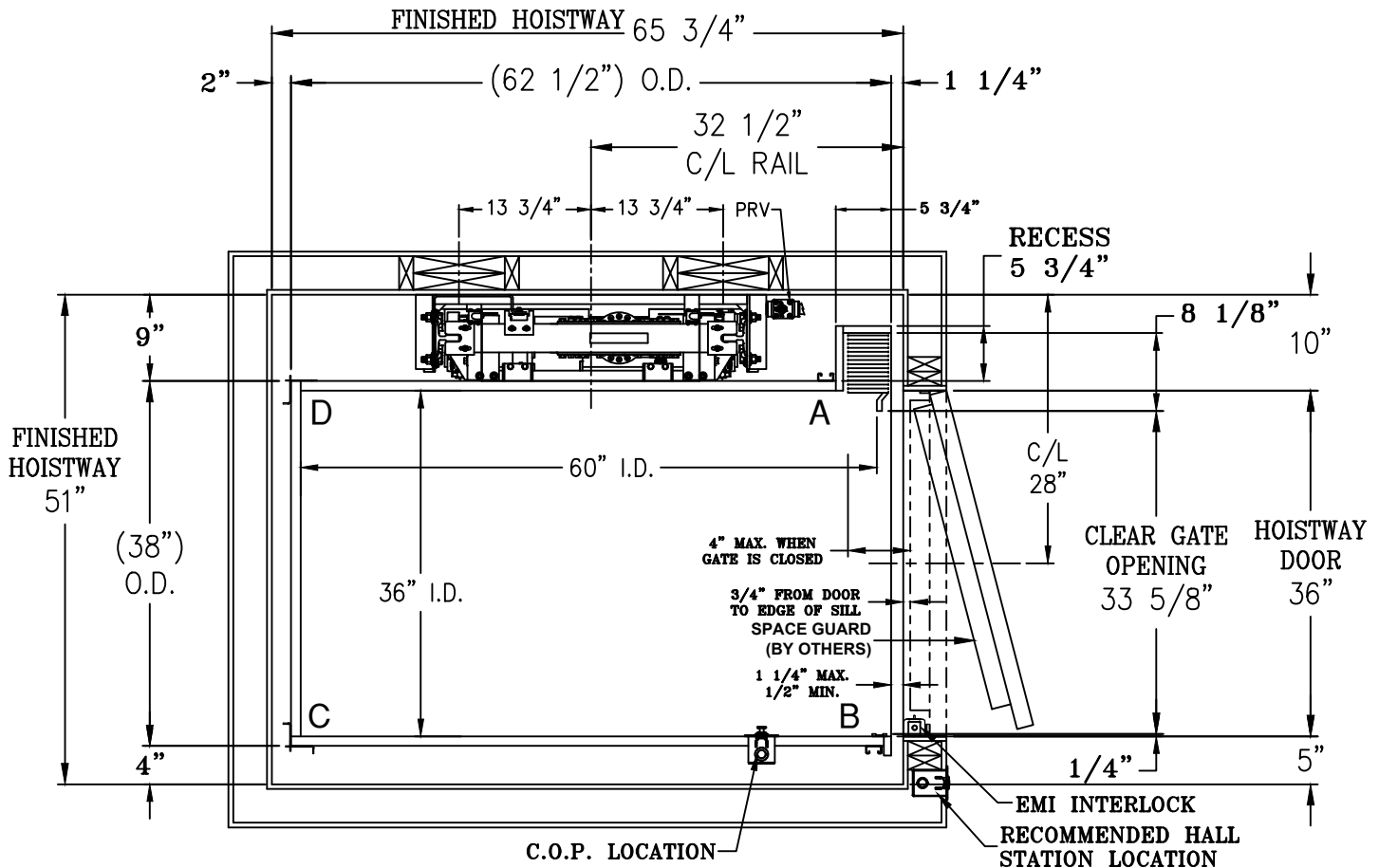

Dave Russo
Access Elevator, Ltd

www.accesselevatortld.com

94 Verdi Street
Farmingdale, NY 11735
631-694-4400 ph
631-454-6311 fax

david@accesselevatortld.com

- 1) HOISTWAY BY OTHERS PER CODE. WALLS TO BE PLUMB AND SQUARE. ALL HOISTWAY DOORS BY OTHERS PER CODE.
- 2) FINISHED HOISTWAY = ROUGH FRAMING + DRYWALL + PLASTER + PAINT.
- 3) 2 7/8" MINIMUM WIDTH REQUIRED TO MOUNT LOCK TO JAMB.

FOX VALLEY		1726 North Ballard Road Appleton, WI 54911 Phone: 800-238-8739	
ELEVATOR			
ELEVATOR CONTRACTOR:			
JOB NAME:		ORDER NUMBER:	
EXCELEVATOR SERIES HYDRAULIC ELEVATOR ABR OPENING W/ ACCORDION GATE			
DRAWN BY:	DATE:	SIGNATURE OF APPROVAL	DWG. NO. C-002852